

GTMR 386 A

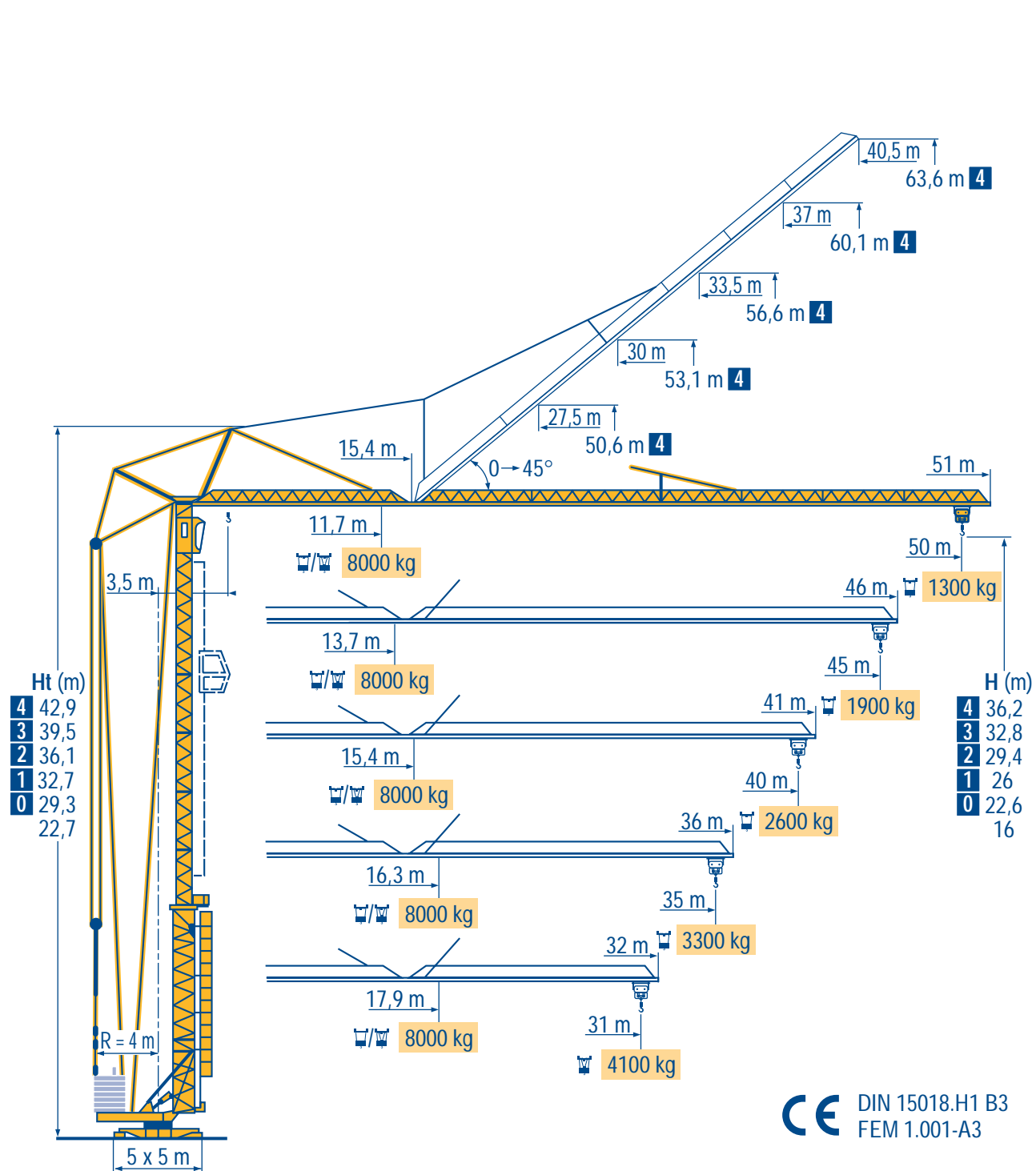

LMT 2

CE DIN 15018.H1 B3
FEM 1.001-A3



POTAIN 

Courbes de charges
Lastkurven



Load diagrams
Curvas de cargas



Curve di carico
负荷曲线



50 m	3,5	▶	11,7	15	17	19	20,8	21	23	25	27	29	31	33	35	37	38	40	42	45	48	50	m
			8000	5780	4920	4260	-	3740	3300	2980	2690	2440	2230	2050	1890	1740	1680	1550	1450	1300	1180	1100	kg
							4000	3940	3530	3180	2890	2640	2430	2250	2090	1940	1880	1750	1650	1500	1380	1300	kg
45 m	3,5	▶	13,7	17	19	21	23	24,6	25	27	29	31	33	35	37	38	40	42	45				m
			8000	6070	5280	4650	4150	-	3730	3380	3080	2830	2600	2410	2230	2150	2010	1880	1700				kg
							4000	-	3580	3280	3030	2800	2610	2430	2350	2210	2080	1900					kg
40 m	3,5	▶	15,4	17	19	21	23	25	27	28	29	31	33	35	37	40							m
			8000	7070	6160	5440	4860	4380	3980	-	3640	3340	3090	2860	2660	2440							kg
									4000	-	3540	3290	3060	2860	2600								kg
35 m	3,5	▶	16,3	19	21	23	25	27	29	29,8	31	33	35										m
			8000	6630	5860	5240	4730	4300	3930	-	3620	3340	3100										kg
									4000		3820	3540	3300										kg
31 m	3,5	▶	17,9	19	21	23	25	27	29	31													m
			8000	7460	6600	5910	5340	4860	4450	4100													kg
										4000													kg

LMT 1

Flèche relevée
Ausleger in Steilstellung



Luffing jib
Flecha izada



Braccio impennato
起升吊臂

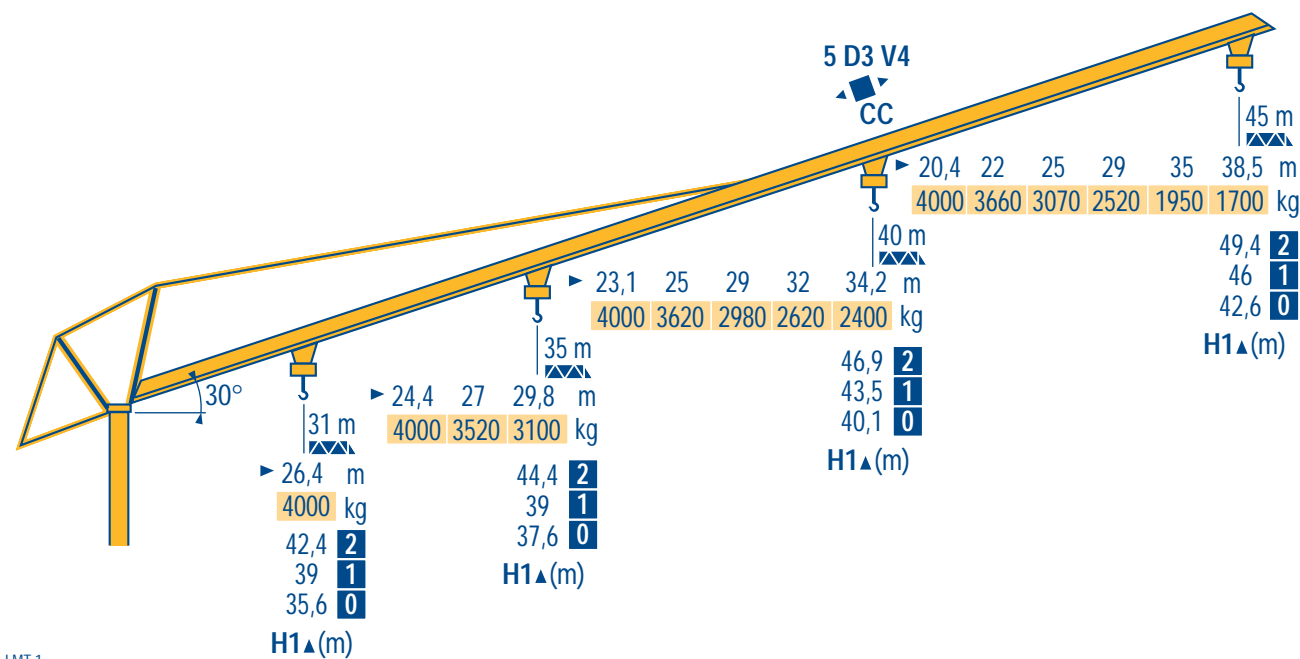

LMT 1

Chariot distributeur et courbes de charges



Traversing trolley and load diagrams



Carrellino distributore e curve di carico



Verfahrbare Laufkatze und Lastkurven



Carro distribuidor y curvas de cargas



变副滑车和负荷曲线





F1 ● 45 t ■ 38 t

31 t

LMT 1

● Réactions en service
■ Réactions hors service
A vide sans lest (ni train de transport) avec flèche et hauteur maximum

F

Reactions in service
Reactions out of service
Without load, ballast (or transport axles), with maximum jib and maximum height.

GB

Reazioni in servizio
Reazioni fuori servizio
A vuoto, senza zavorra (ne assali di trasporto) con braccio massimo e altezza massima

I

● Reaktionskräfte in Betrieb
■ Reaktionskräfte außer Betrieb
Ohne Last, Ballast (und Transportachse), mit Maximalausleger und Maximalhöhe.

D

Reacciones en servicio
Reacciones fuera de servicio
Sin carga, sin lastre, (ni tren de transporte), flecha y altura máxima.

E

工作状态下的反应
非工作状态下的反应
空载无压重也无运输车
有吊臂和最大高度

C

Mécanismes
Antriebe

F

Mechanisms
Mecanismos

D

GB

Meccanismi
机构

E

I

C

		Turtle			Deer			ch - PS hp	kW	
▲▼	33 PC 20	m/min	5,4	30	60	2,7	15	30	33	24
		kg	4000	4000	2000	8000	8000	4000		
▲▼	33 LVF 20	m/min	5,4	31	62	2,7	15,5	31	33	24
		kg	4000	4000	2000	8000	8000	4000		
◀▶	5 D3 V4	m/min	15 - 30 - 58						5,5	4
⦿	RCV 62	tr/min U/min rpm	0 → 0,8						8	5,9
⦿ R ≥ 8 m	H ≤ 32,8 m	m/min	25						2 x 4	2 x 3

CEI 38



IEC 38

kVA



400 V (+6% -10%) 50 Hz

50 kVA

84/534 - 87/405

LMT 2

▲▼ Leverage
◀▶ Distribution
⦿ Orientation
● Translation
Conforme aux directives CEE 84/534 et 87/405 sur le niveau acoustique

F

Hoisting
Trolleying
Slewing
Travelling
In compliance with the EEC 84/534 and 87/405 Instructions on noise level

GB

Sollevamento
Distribuzione
Rotazione
Traslazione
Conforme alle direttive CEE 84/534 e 87/405 sul livello acustico

I

▲▼ Heben
◀▶ Katzfahren
⦿ Schwenken
● Kranfahren
Gemäss EWG-Richtlinien 84/534 und 87/405 für den Schall-Leistungspegel

D

Elevación
Distribución
Orientación
Traslación
Conforme con las directivas CEE 84/534 y 87/405 sobre el nivel acustico

E

起升
变幅
回转
行走
符合 CEE 84/534 - CEE 87/405 声晌度规定

C

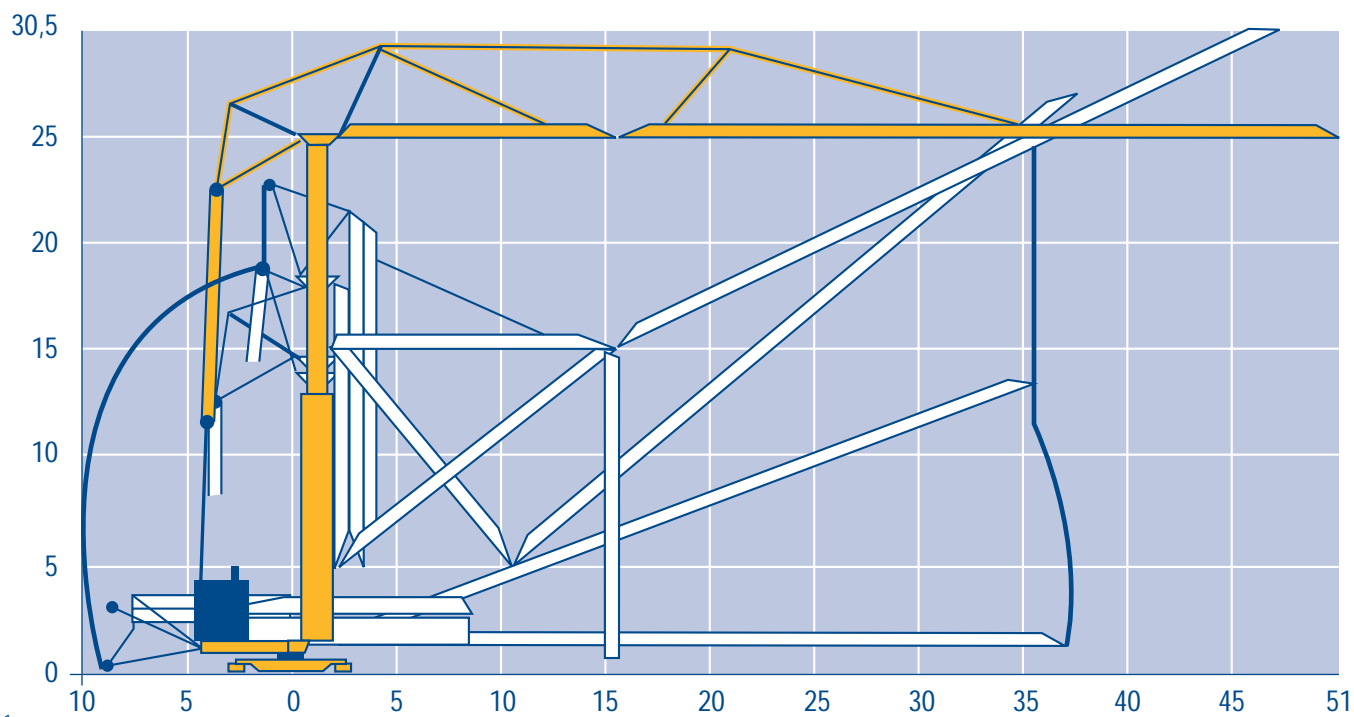

Transport
Version semi-portée
Transport
Ausführung als Sattelaufleger

F Transport
Tractor towed version
D Transporte
Versión en semi-remolque

GB Trasporto
Versione semi rimorchio
E 运输
半拖挂

I
C

S4/S215M
S5B/J215M

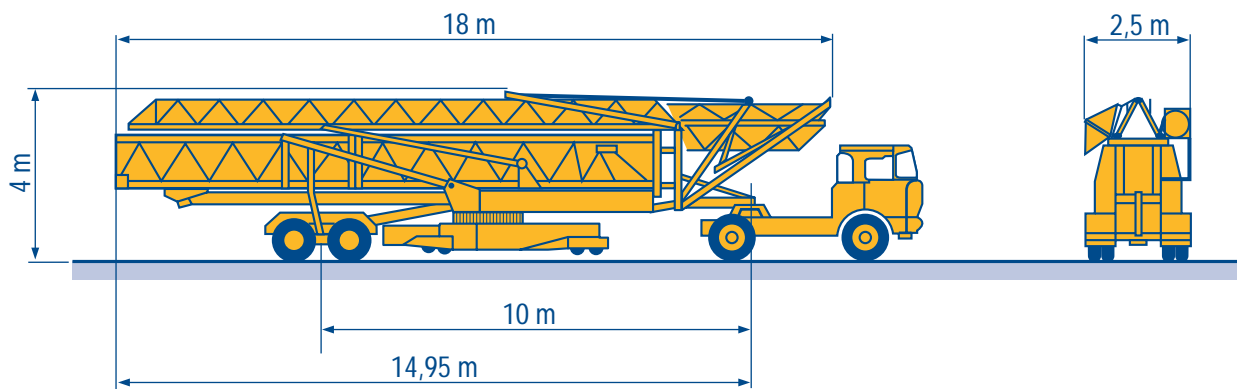

POTAIN 
GROUPE LEGRIS INDUSTRIES

18.Rue de Charbonnières, B.P. 173
F-69132 ECULLY Cedex
Tél. (33)04.72.18.20.20
Fax (33)04.72.18.20.00
<http://www.potain.com>
E-mail : mkt@potain.fr

GTMR 386 A

Copyright.Reproduction interdite © POTAIN 1997





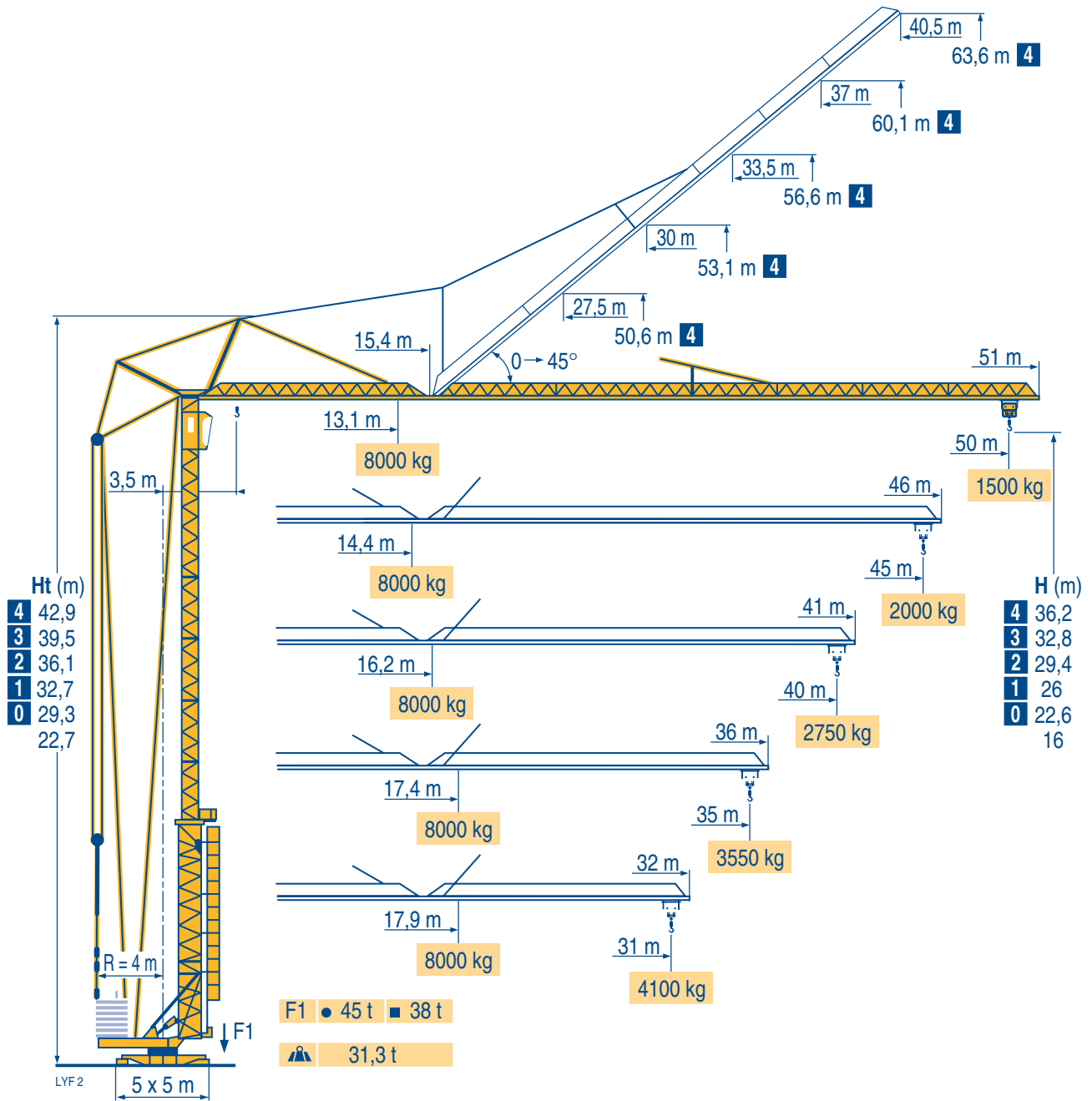











Deutschland
POTAIN GmbH Tel : 06.105.704.0
Italia
POTAIN S.p.A. Tel : 039.65.631
Singapore
POTAIN PTE LTD Tel : (00.65) 227.1550

GTMR 386 B



Mécanismes
Antriebe
Mechanisms
Mecanismos
Meccanismi
Mecanismos

LVF 1

								ch - PS hp	kW	
										
	33 PC 20	m/min	5,4	30	60	2,7	15	30	33	24
		kg	4000	4000	2000	8000	8000	4000		
	33 LVF 20	m/min	5,4	31	62	2,7	15,5	31	33	24
		kg	4000	4000	2000	8000	8000	4000		
	5 D3 V4	m/min	15 - 30 - 58						5,5	4
	RCV 62	tr/min U/min rpm	0 → 0,8						8	5,9
  H ≤ 32,8 m R ≥ 8 m		m/min	25						2 x 4	2 x 3
CEI 38		 IEC 38	 kVA							
400 V (+6% -10%) 50 Hz		50 kVA			2000/14					

Montage
Montage
Erection
Montaje
Montaggio
Montagem

LVF 1

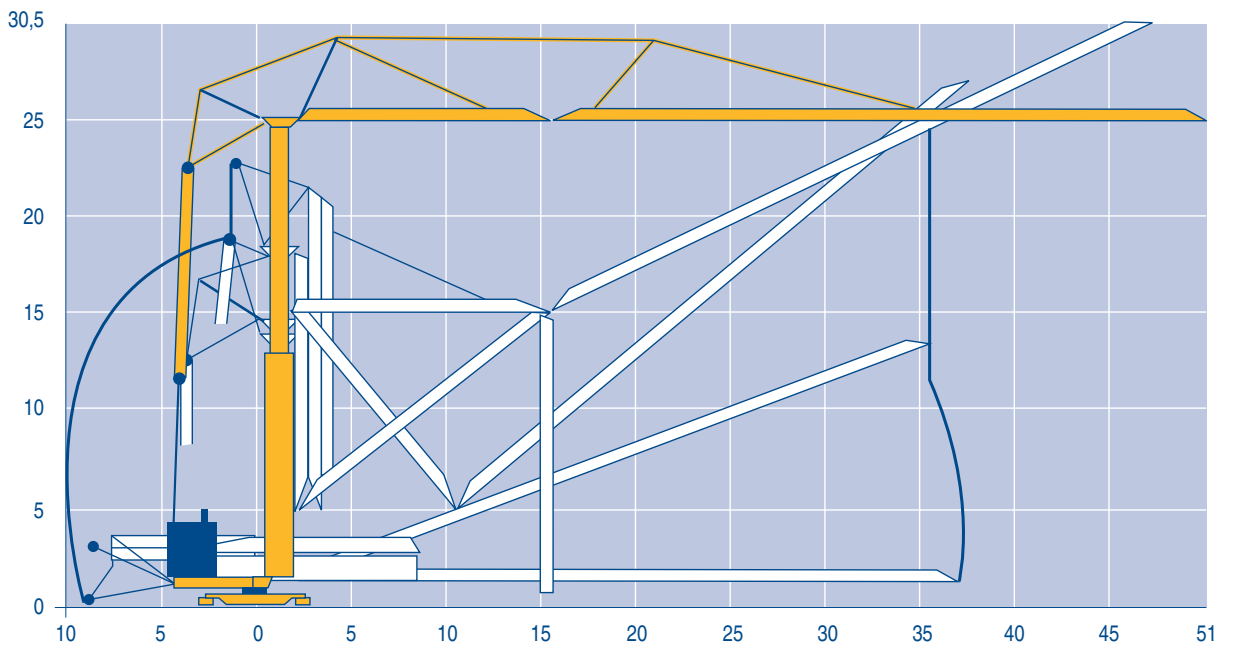

GTMR 386 B

POTAIN 



F	D	GB	E	I	P
Levage	Heben	Hoisting	Elevación	Sollevamento	Elevação
Distribution	Katzfahren	Trolleying	Distribución	Distribuzione	Distribuição
Orientation	Schwenken	Slewing	Orientación	Rotazione	Rotação
Translation	Kranfahren	Travelling	Traslación	Traslazione	Translação
Conforme aux directives CEE sur le niveau acoustique	Gemäss EWG-Richtlinien für den Schall-Leistungspegel	In compliance with the EEC Instructions on noise level	Conforme con las directivas CEE sobre el nivel acústico	Conforme alle direttive CEE sul livello acustico	Conforme as directivas CEE sobre o nível acústico

Transport
 Transport
 Transport
 Transporte
 Trasporto
 Transporte

S4/S215M
 S5B/J215M

LYF 1

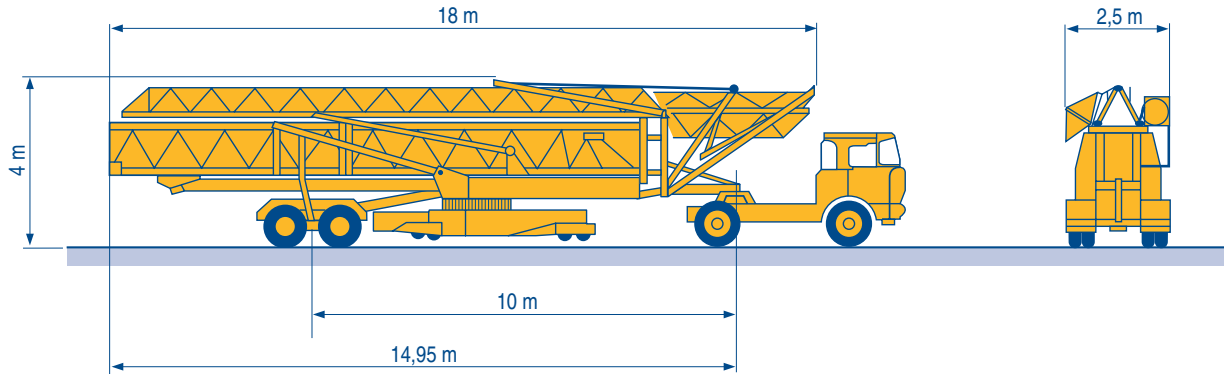

Document commercial non contractuel. Pour toute information technique se référer à la notice correspondante

Unverbindliches Vertriebsdokument. Für technische Informationen, siehe die entsprechenden Anweisungen.

This commercial document is not legally binding. For any technical information, please refer to the corresponding instructions.

Documento commercial non contractuel. Para cualquier información técnica, ver la noticia correspondiente.

Documento commerciale non vincolante. Per tutte le informazioni tecniche fare riferimento al catalogo istruzioni

Documento comercial não contratual. Para qualquer informação técnica complementar consultar as respectivas instruções



18, rue de Charbonnières - B.P.173
 69132 ECULLY Cedex - France

Tél. : (33) 4 72 18 20 20
 Fax. : (33) 4 72 18 20 00
 www.manitowoccrane.com www.potain.com

Americas
 Tel: +1 920 683 6322
 Tel: +1 717 597 8121

Europe - Middle East - Africa
 Tel : +(33) 4 72 81 50 00
 Tel : +(44) 191 565 6281

Asia - Pacific
 Tel: +(65) 6861 7133
 Fax: +(65) 6862 4142

www.manitowoccrane.com

GTMR 386 B
 Réf. 2003 48 LYF 2

Copyright.Reproduction interdite © POTAIN 2003

Réalisation HeadLines